

University of Michigan Carbon Fiber Array Catalog

Last Updated: 10-17-2021

Table of Contents

Table of Contents	2
Introduction	3
General Information	4
HDCF Array	5
Carbon Fiber Numbering	6
Silicon Shank Dimensions	7
3mm HDCF Array	7
6mm HDCF Array	7
9mm HDCF Array	7
Interface Board Specifications and Connector Mapping	8
18-pin Omnetics Interface Board	8
ZIF Interface Board	9
Flex Array v3	10
Carbon Fiber Numbering	11
Connector Mapping	12
Flex Array v4 (legacy)	13
Carbon Fiber Numbering	14
Connector Mapping	15
Tip Functionalization	16
Laser Cut	16
Blowtorch Sharpened	16
Laser Ablation	17
FAQs	18
References	19
HDCF Array	19
Flex Array	19

Introduction

This catalog details the available probes provided by the [Chestek lab](#) through a [NeuroNex MINT](#) distribution grant (NSF 1707316). If you would like to request devices or have additional questions, please email Paras Patel (parasp@umich.edu).

General Information

All arrays, unless requested otherwise, come with pure silver ground and/or references wires. The standard configuration is for the wires to be 50mm long with 20mm exposed at the end.

All arrays, unless requested otherwise, are coated with approximately 800nm of Parylene C, before tip functionalization.

HDCF Array

The high density carbon fiber (HDCF) array is a combination of a silicon support shuttle or shanks with 16 carbon fibers. The tapering shanks provide permanent mechanical support during the insertion of the carbon fibers. The fixed portion of silicon + carbon fiber comes in 3mm, 6mm, or 9mm lengths. The protruding portion of carbon fiber can be cut to any length (typically 100-300 μ m) and the [tips functionalized](#) to meet different application needs. The arrays can be attached to different [interface boards](#) that are compatible with commercially available recording hardware.

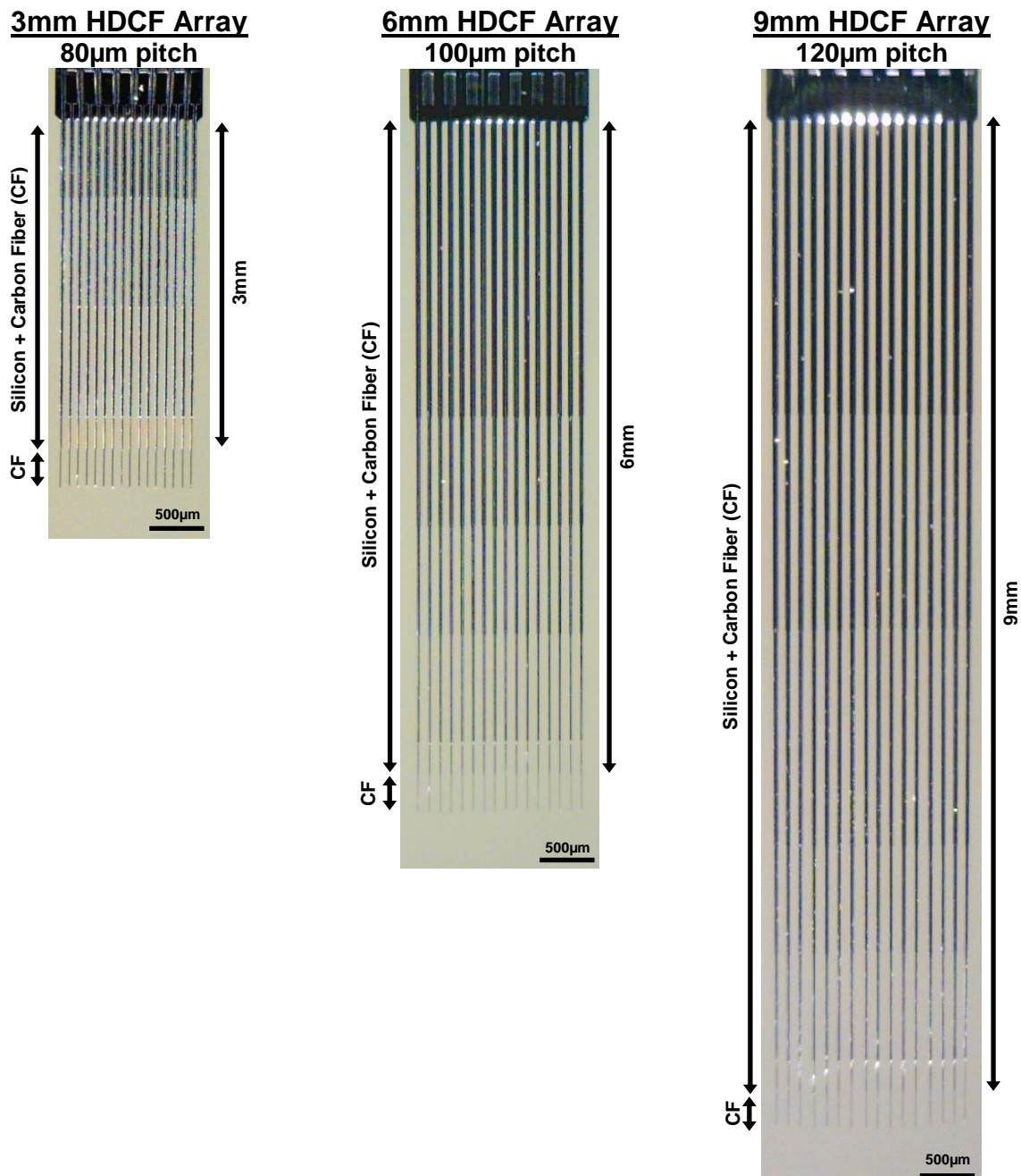

Carbon Fiber Numbering

The diagram below indicates the numerical order of the carbon fibers which is used for all related documentation and mapping. The image below assumes the front of the device is facing the user and the fibers are pointing down.

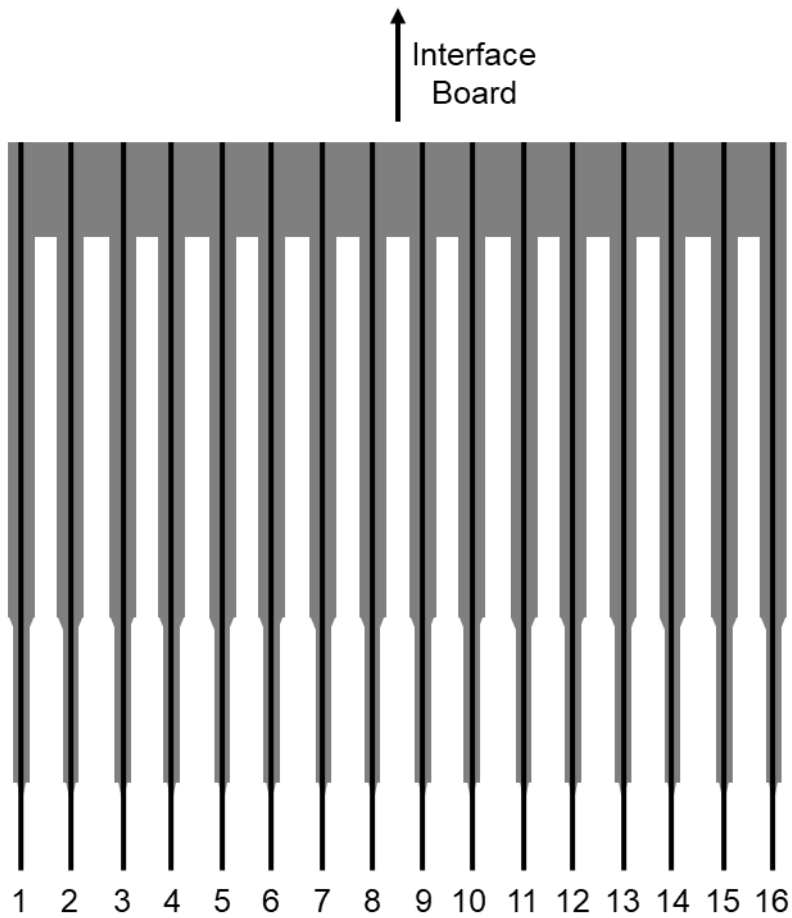

Silicon Shank Dimensions

The exact dimensions of the tapering silicon shanks are shown below.

3mm HDCF Array

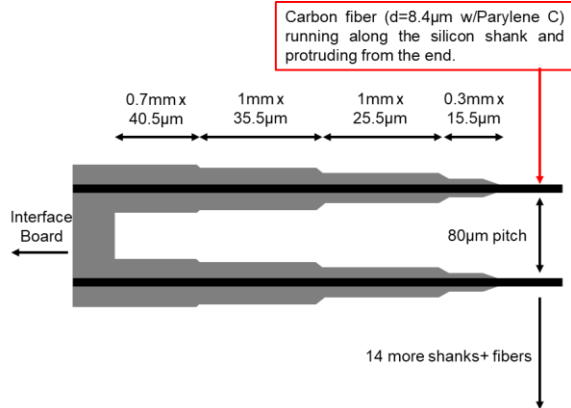

6mm HDCF Array

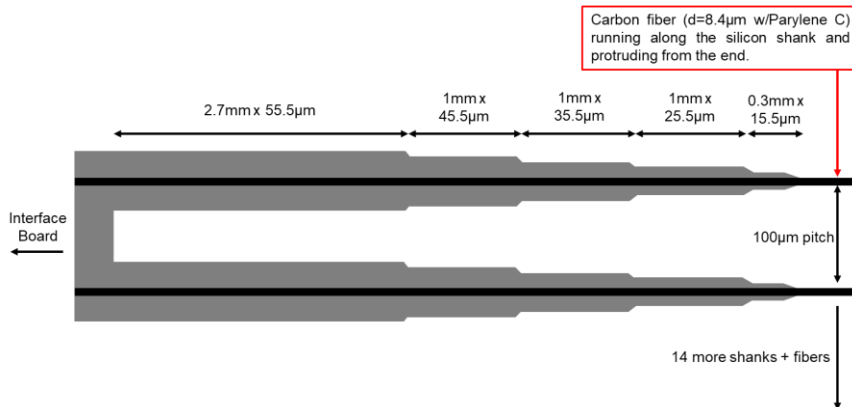

9mm HDCF Array

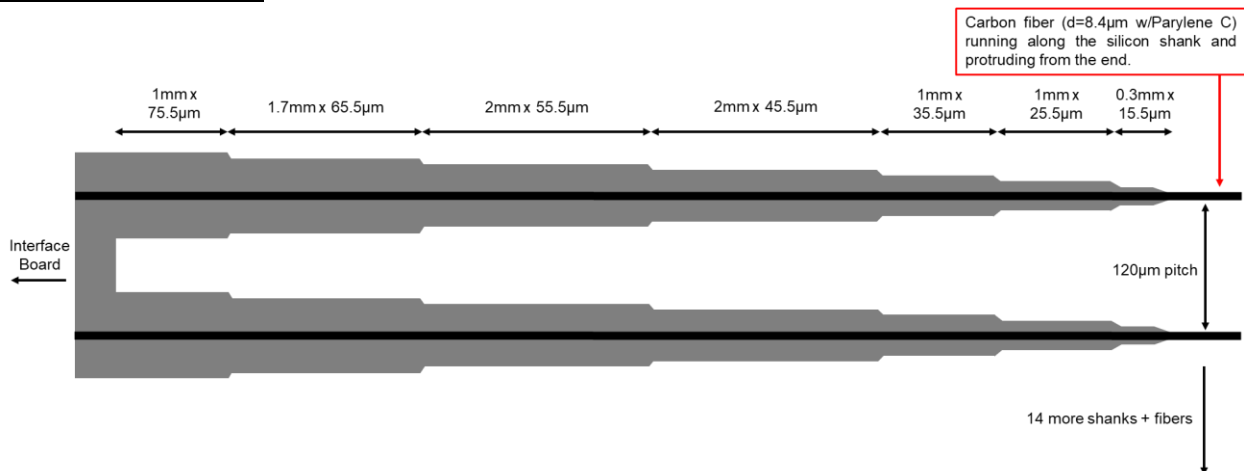

Interface Board Specifications and Connector Mapping

Interface boards provide the backend connections to the different HDCF arrays. Any size array can be paired with any interface board listed below.

18-pin Omnetics Interface Board



Connector: 18-pin Omnetics (A79040-001)

Dimensions: 7.4mm (w) x 12.1mm (h)

Weight: ~0.26g

Electrophysiology Headstage Compatibility:

- Intan RHD 16ch
- Intan RHS 16ch

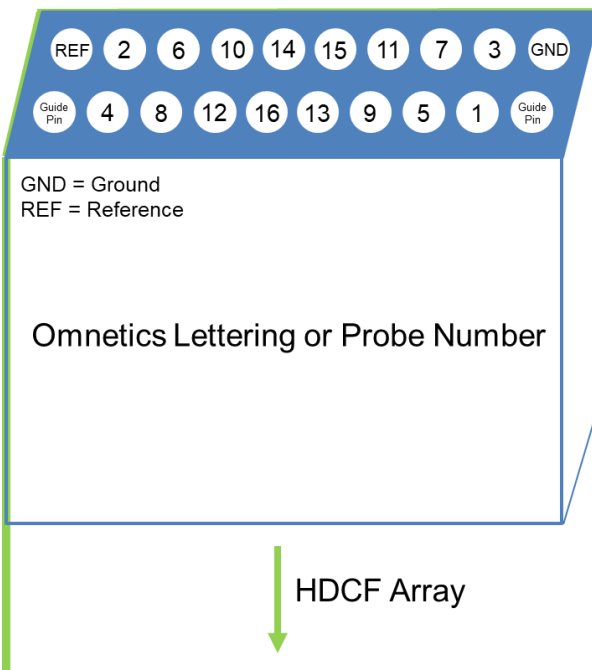

Carbon fiber number mapping for the above interface board. See headstage manufacturer's documentation for corresponding channel mapping.

ZIF Interface Board



Connector: 20-pin Hirose (DF30FC-20DS-0.4V(82))

Dimensions: 7mm (w) x 11mm (h)

Weight: ~0.23g

Electrophysiology Headstage Compatibility:

- Tucker-Davis Technologies ZC16
- Tucker-Davis Technologies ZC32
- Tucker-Davis Technologies ZD32

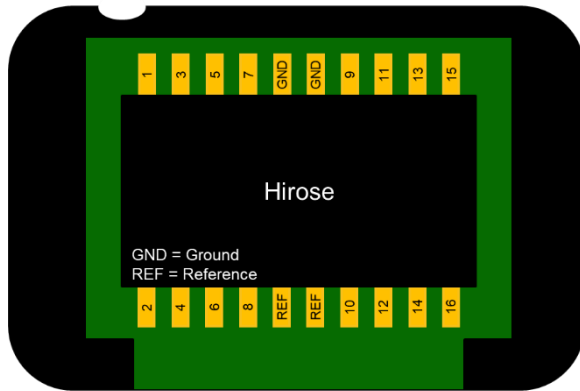

Carbon fiber number mapping for the above interface board. See headstage manufacturer's documentation for corresponding channel mapping.

Flex Array v3

The flex array consists of a flexible polyimide board with 16 carbon fibers protruding from the end. The board's polyimide shank length is fixed at 10mm. The protruding portion of carbon fiber at the end of the board can be cut to any length (typically 150-500 μ m) and the [tips functionalized](#) to meet different application needs.

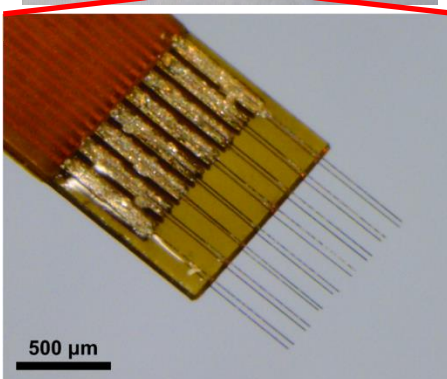
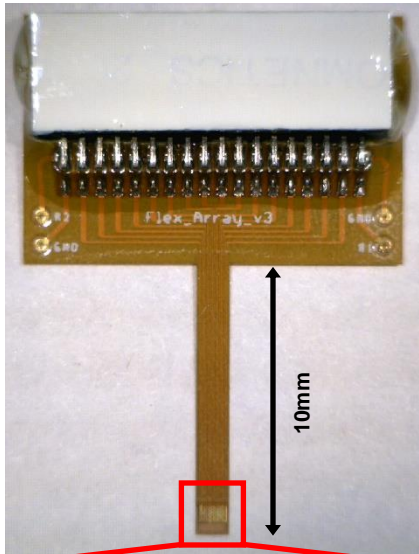

Connector: 36-pin Omnetics (A79024-001)

Dimensions: 14mm (w) x 19.2mm (h)

Shank Length: 10mm

Weight: ~0.26g

Electrophysiology Headstage Compatibility:

- Intan RHD 32ch (32 unipolar)

Carbon Fiber Configuration:

- Up to 16 fibers in two rows of 8
- 132 μ m pitch within a row
- 50 μ m between rows of fibers
- Fiber length 150-500 μ m

Carbon Fiber Numbering

The diagram below indicates the numerical order of the carbon fibers which is used for all related documentation and mapping. The image below assumes the front of the device is facing the user and the fibers are pointing down. The top/front row of fibers are numbered 1 through 8 in sequential order. The bottom/back row of fibers are numbered 9 through 16 in sequential order.

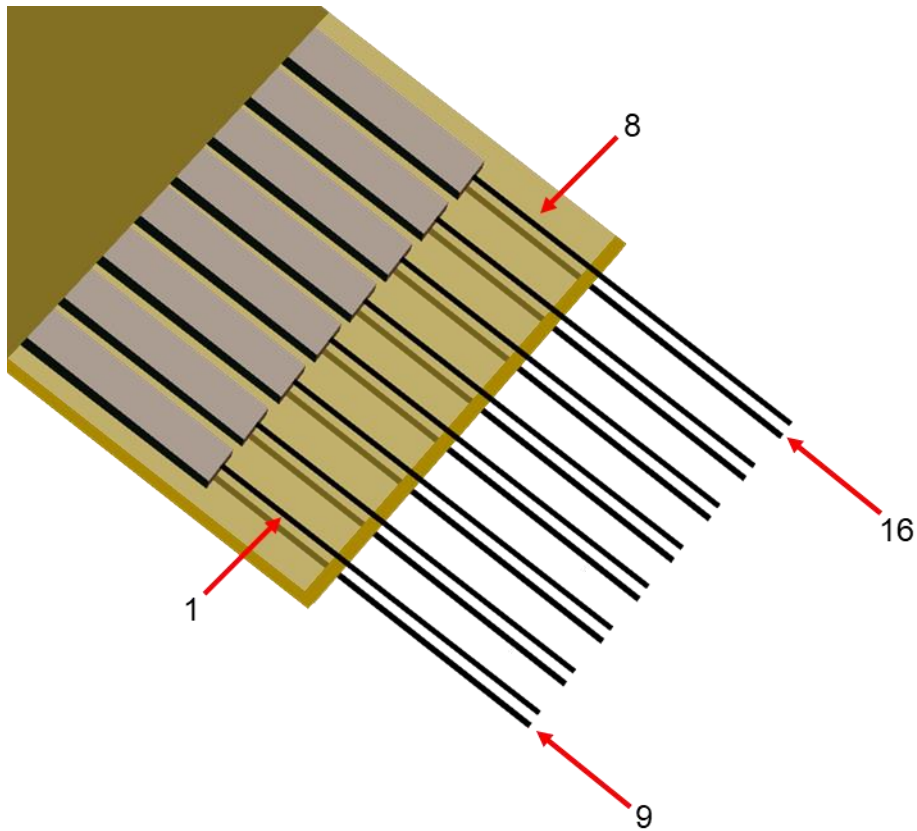

Connector Mapping

Carbon fiber number mapping for the flex array. See headstage manufacturer's documentation for corresponding channel mapping. Note, two traces/pins are connected to each fiber, therefore there is a redundancy in the mapping.

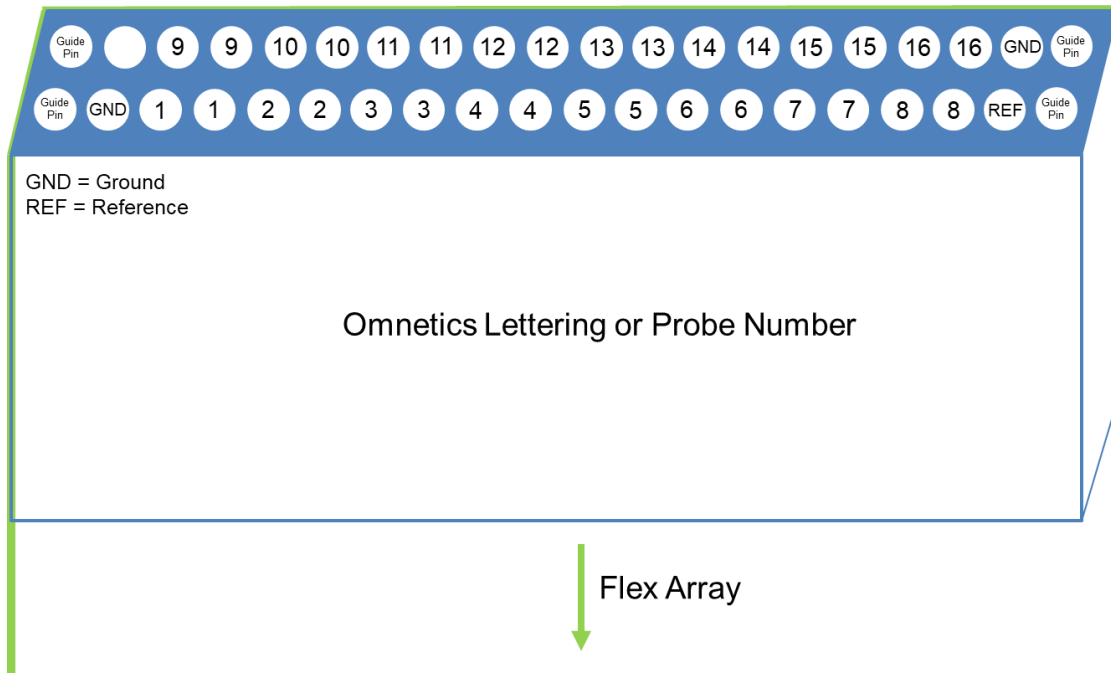

Flex Array v4 (legacy)

The flex array consists of a flexible polyimide board with 16 carbon fibers protruding from the end. The board's polyimide shank length is fixed at 3mm. The protruding portion of carbon fiber at the end of the board can be cut to any length (typically 150-500 μ m) and the [tips functionalized](#) to meet different application needs.

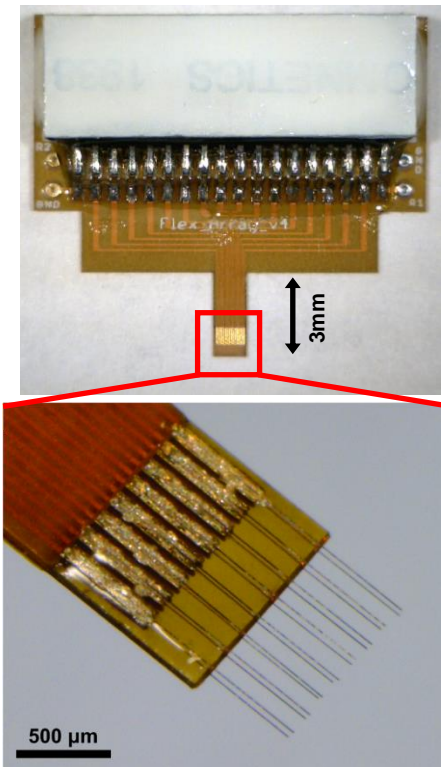

Connector: 36-pin Omnetics (A79024-001)

Dimensions: 14mm (w) x 12.2mm (h)

Shank Length: 3mm

Weight: ~0.26g

Electrophysiology Headstage Compatibility:

- Intan RHD 32ch (32 unipolar)

Carbon Fiber Configuration:

- Up to 16 fibers in two rows of 8
- 132 μ m pitch within a row
- 50 μ m between rows of fibers
- Fiber length 150-500 μ m

Carbon Fiber Numbering

The diagram below indicates the numerical order of the carbon fibers which is used for all related documentation and mapping. The image below assumes the front of the device is facing the user and the fibers are pointing down. The top/front row of fibers are numbered 1 through 8 in sequential order. The bottom/back row of fibers are numbered 9 through 16 in sequential order.

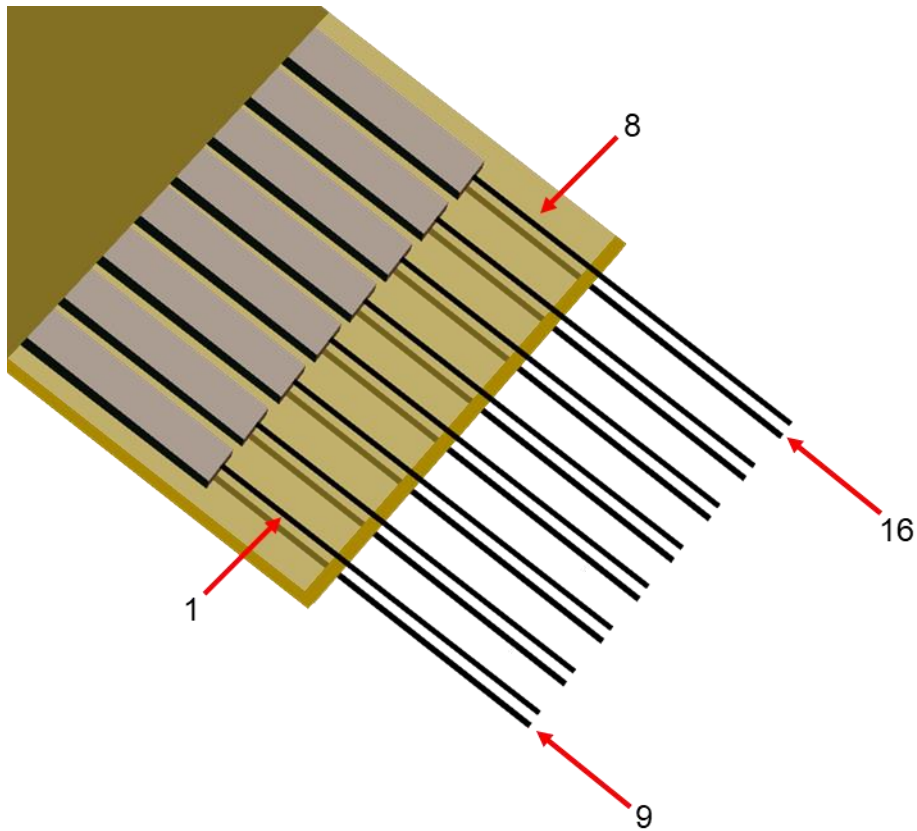

Connector Mapping

Carbon fiber number mapping for the flex array. See headstage manufacturer's documentation for corresponding channel mapping. Note, two traces/pins are connected to each fiber, therefore there is a redundancy in the mapping.

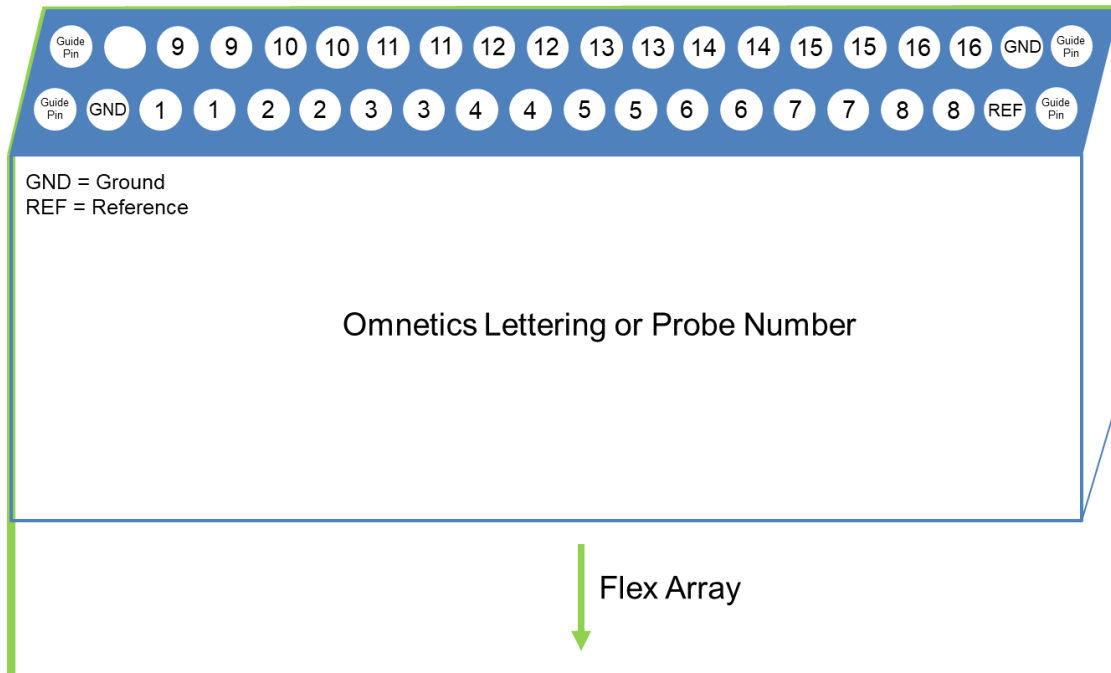

Tip Functionalization

The tips of the carbon fibers can be functionalized according to the end user's application. All fibers are coated with Parylene C before the tip functionalization step. Note, only one tip functionalization method can be applied per array.

Laser Cut

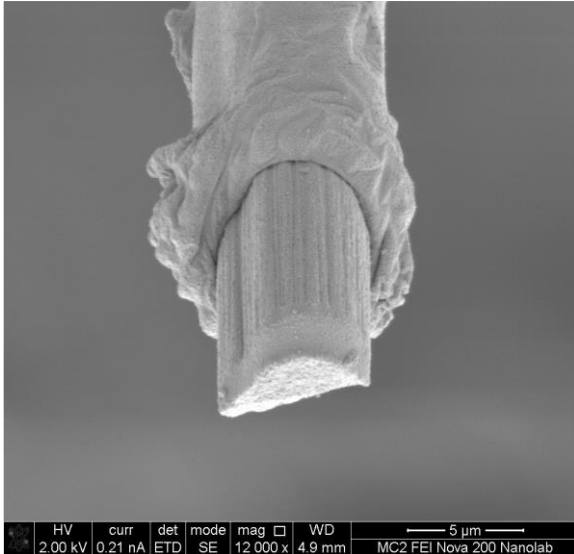

Application: Electrophysiology

Exposed Length: 5-8 μ m

Plating: PEDOT or Ptlr

References: Welle et al., Journal of Neural Engineering, 2020

Blowtorch Sharpened

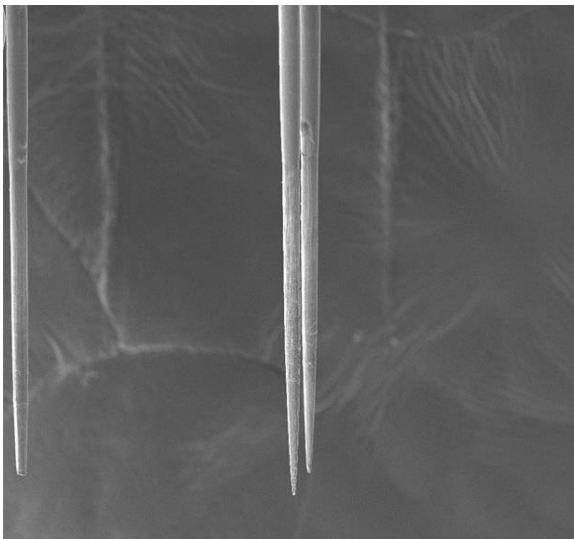

Application: Electrophysiology and/or Stimulation

Exposed Length: 100-150 μ m

Plating: PEDOT or Ptlr (required for stimulation)

References: Welle et al., IEEE TNSRE, 2021

Laser Ablation

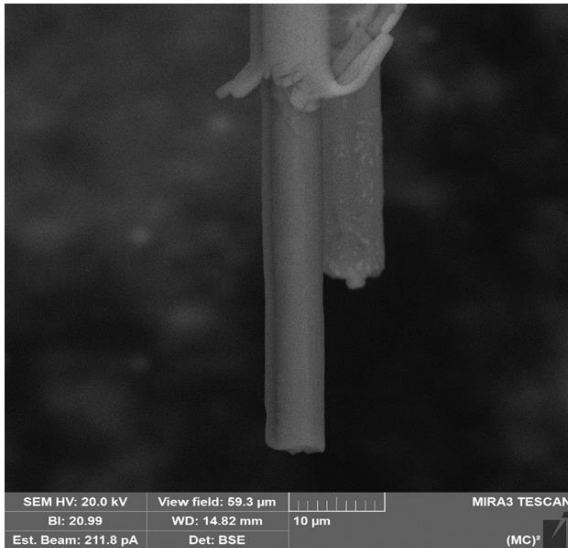

Application: Fast Scan Cyclic Voltammetry

Exposed Length: 50-100μm

Plating: None

References: Patel et al., Journal of Neural Engineering, 2020

FAQs

Answers to some frequently asked questions regarding all of our arrays.

Can these arrays be sterilized?

Yes, these arrays can be sterilized using ethylene oxide. If you do choose to sterilize using ethylene oxide, you can keep them in the original box. We do not recommend using steam sterilization.

Can these arrays be re-used?

Yes, labs have reused these devices in acute/non-survival preparations.

What are the ground and reference wires?

The wires are 50mm long Teflon coated silver wire (AWG 36) with 20mm exposed at the end.

References

HDCF Array

- Huan Y, Gill JP, Fritzing JB, Patel PR, Richie JM, della Valle E, Weiland JD, Chestek CA, Chiel HJ. Carbon Fiber Electrodes for Intracellular Recording and Stimulation. bioRxiv. 2021 Jan 1.

Flex Array

- Welle EJ, Woods JE, Jiman AA, Richie JM, Bottorff EC, Ouyang Z, Seymour JP, Patel PR, Bruns TM, Chestek CA. Sharpened and Mechanically Durable Carbon Fiber Electrode Arrays for Neural Recording. IEEE Transactions on Neural Systems and Rehabilitation Engineering. 2021 Jun 8 (pp. 993-1003). IEEE
- Richie JM, Patel PR, Welle EJ, Dong T, Chen L, Shih AJ, Chestek CA. Benchtop Carbon Fiber Microelectrode Array Fabrication Toolkit. bioRxiv. 2021 Mar 22.
- Jiman AA, Ratze DC, Welle EJ, Patel PR, Richie JM, Bottorff EC, Seymour JP, Chestek CA, Bruns TM. Multi-channel intraneural vagus nerve recordings with a novel high-density carbon fiber microelectrode array. Scientific Reports. 2020 Sep 23;10(1):1-3.
- Patel PR, Popov P, Caldwell CM, Welle EJ, Egert D, Pettibone JR, Roossien DH, Becker JB, Berke JD, Chestek CA, Cai D. High density carbon fiber arrays for chronic electrophysiology, fast scan cyclic voltammetry, and correlative anatomy. Journal of Neural Engineering. 2020 Oct 13;17(5):056029.